



- /// WUXGA 6500 Lumens
- /// Lens shift
- /// Extensive lens options
- /// Dual lamp

EH7500

*Spectacular image quality, outstanding
brightness and ultimate reliability*



PRO | SCENE

PRO|SCENE

For more than ten years Optoma has been one of the world's foremost projector designers and manufacturers - amongst the very few companies that focus exclusively on projectors.

Today the Optoma ProScene range represents the evolution of projection expertise, honed and refined by manufacturing and supporting millions of projectors the world over. This knowledge and skill has been distilled into the ProScene products and support services which are designed specifically for demanding professional applications.

- ✓ Higher education
- ✓ Auditoriums
- ✓ Conference rooms
- ✓ Meeting rooms
- ✓ Lecture theatres
- ✓ Boardrooms
- ✓ Digital signage
- ✓ Post production
- ✓ Houses of worship
- ✓ Broadcast studios
- ✓ Stage shows
- ✓ Theatre
- ✓ Museums
- ✓ Large classrooms
- ✓ Live events
- ✓ Trade shows
- ✓ Exhibitions
- ✓ Projection Mapping

ProScene Certified Partners

Optoma understands that for ProScene customers, their high specification projector must be of exceptional quality and that the level of support and expertise provided by AV installers and integrators must also be of the highest calibre. To maintain this standard throughout, we have selected only the very best from within the AV industry to become ProScene Certified Partners.

These rigorously selected partners understand your specific requirements and perhaps as importantly, they have direct access to the specially-trained Optoma support and service teams. Our dedicated experts are available from the initial design and planning phase of a project, right through to the installation stages and beyond. Through our partners, you'll have access to what is probably the most extensive network of service centres across Europe of any projector manufacturer.

Choosing your ProScene projector is just the start. Total support and service excellence are the core of the ProScene ideology, ensuring industry leading dedication to giving you the highest standard of expertise from Optoma and from our certified partners.

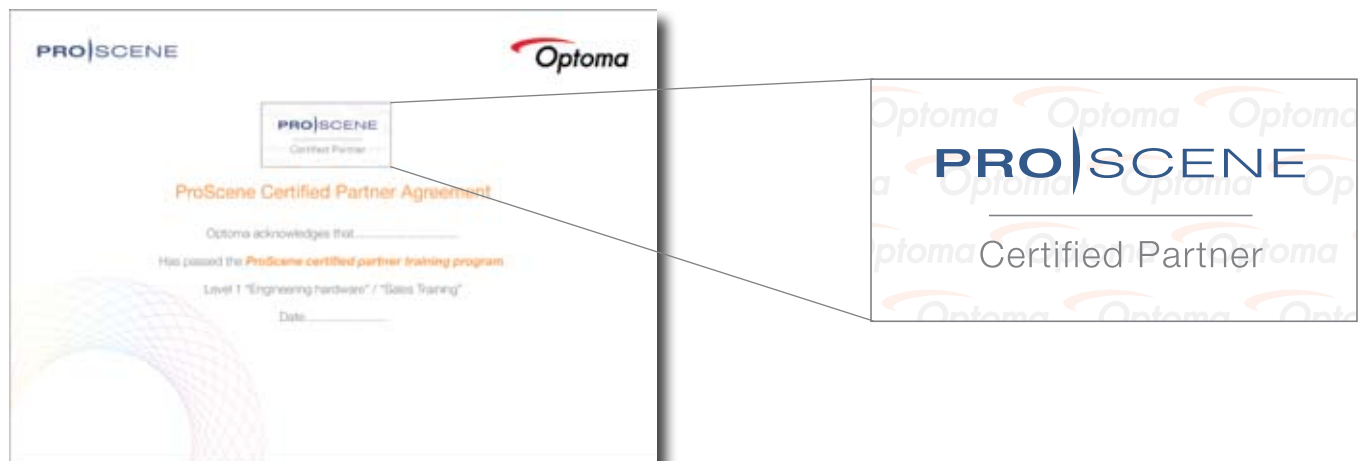

Features



The ProScene EH7500 is the epitome of our projection expertise in a single product; a revolution; a product designed exclusively for demanding professional applications.

Dual-lamp, WUXGA and 6500 lumens delivers bright crystal clear images, ultimate reliability and 24/7 operation to ensure that this is a projector on which you can rely. The dust-sealed, filter-free design prevents dust and dirt from affecting the system – ensuring optimal image quality with minimal maintenance. Motorised lens shift, focus and zoom combined with the extensive lens options and interchangeable colour wheels, provide installation flexibility for simple, trouble free use in a wide variety of situations.

EH7500 features



6500L



Native WUXGA (1920x1200) - 50% more pixels than SXGA+



Dual Lamp – 24/7 operation, multiple redundancy, longer service intervals



Installation flexibility - 5x Lens options, motorised lens shift, focus and zoom



Interchangeable colour wheel – Tailor the performance to suit the application



Image Quality



Superb image quality is at the heart of every ProScene product design. At every step, commencing with the incredibly reliable, high resolution WUXGA DLP® chip, where the image is initially created, via the P-VIP lamp pulsing technology that fine tunes the colour to exacting standards, through to the precision optics to focus the image on a screen, accuracy and integrity of the image are paramount.

ProScene chose DLP® technology for its image quality and unmatched reliability. The reflective nature of DLP® micro-mirror technology provides highly efficient bright images with great contrast whilst maintaining precise colour accuracy and natural, real-world colour reproduction. For demanding professional applications, the proven reliability of DLP® technology makes it the obvious choice.

P-VIP lamps

The dual Osram 330W P-VIP lamps provide the highest possible luminance, the essential prerequisite of all highly-efficient projectors. These lamps stay brighter for longer, provide a long operating life and a low loss of luminous flux throughout that life. In addition, the lamp drivers are specifically tuned for the lamps, ensuring not only optimum operating conditions for every situation, but also provide sophisticated lamp pulsing modes and the assurance that colour can be fine tuned according to the application.

Image colour and size control

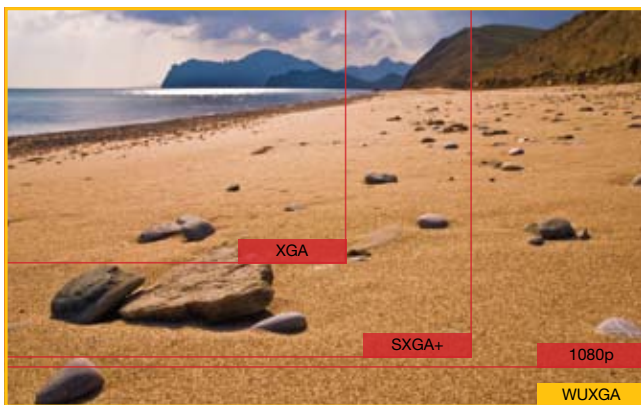

Where detail really matters, the full WUXGA (1920 x 1200) resolution offers 15% more pixels than 1080p and 60% more than SXGA+. This enables unscaled Full HD video and extra detail. Time Code information can be displayed onscreen at the same time, perfect for soundtrack recording & video editing where precise timing can be critical.

Lamp Pulsing Technology

Advanced lamp-pulsing technologies enable colour performance to be fine tuned directly from the lamp. This unprecedented control helps create vibrant, perfectly saturated colours across the whole light spectrum and produces stunningly natural, life-like images.

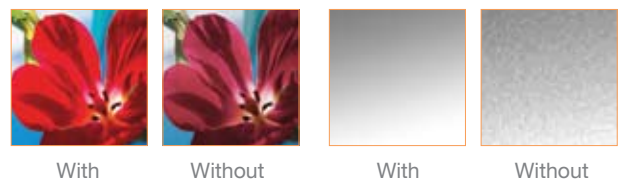
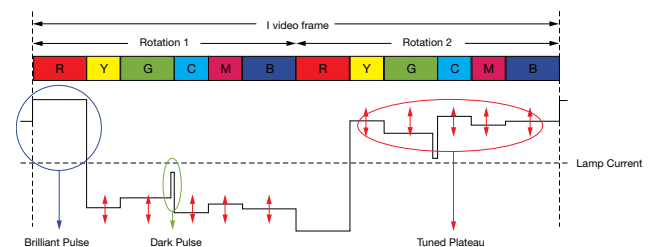

Amazing Colour

The EH7500 incorporates BrilliantColor™ technology to produce stunningly bright images with perfectly balanced life-like colours.

Precision Optics

Aspherical optical elements and the use of Low Dispersion (LD) glass maintain optimum sharpness and focus uniformity over the entire image. The ProScene insistence on uncompromising optical quality ensures extremely low colour flare and chromatic aberration resulting in a crystal clear, high contrast image.



Reliability



All ProScene projectors are designed for continuous 24/7 operation. Only the most reliable, industry proven components are used to ensure superior reliability. This hard-earned “capability” has been meticulously developed over a decade of designing and supporting millions of projectors the world over. ProScene customers can therefore be confident that, as one of the most reliable projector brands in the industry today, Optoma has a reputation for service excellence that is well deserved.



Dual Lamps

Dual lamps enable a level of reliability simply unavailable with a single lamp projector. Both lamps can be used together to achieve maximum brightness, whilst still providing redundancy should one of the lamps fail. Alternatively a single lamp can be used in Relay Mode to combine the full lifetime of each individual lamp and thereby minimise service intervals.

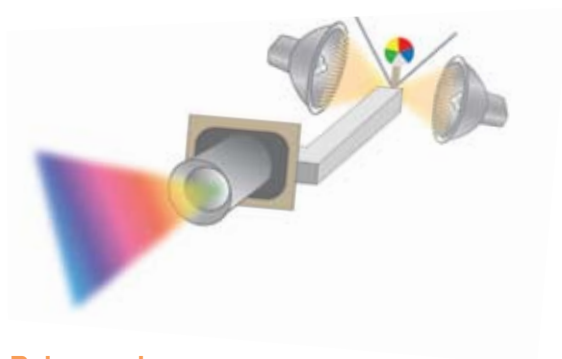

Lamp Relay mode

For challenging installations where the EH7500 is run for long periods, the Lamp Relay function can be used to automatically switch between lamps.



DLP® Technology

DLP® technology from Texas Instruments® is widely recognised and acclaimed for its unmatched reliability and long lasting image performance. When combined with high brightness and native contrast ratios, it becomes the obvious choice for demanding applications. Independent testing has proven DLP® to be the most reliable of projector technologies. Whilst the competition may show image quality decline after only a few thousand hours, DLP® technology can remain unchanged over hundreds of thousands of hours.



Total Cost of Ownership

For demanding applications the total cost of ownership of a projector is not in the purchase cost and replacement lamps but in expensive maintenance and service. ProScene projectors require very little maintenance, have no user serviceable parts inside and no filters that require periodic replacement. The result is low cost, predictable service cycles, enabling planned down time to be minimised.

We are so confident that the EH7500 image colour quality will remain as good as the day you bought it that Optoma will guarantee it for five years.



Flexibility

Installation Flexibility

To help meet the seemingly limitless challenges of ProAV installations the EH7500 provides 5 lens options with motorised zoom and focus to ensure you can get the image size you require. Motorised lens shift helps you get the image exactly where you want it and the 2 colour wheel options ensure you can match the image quality and brightness exactly to the application's requirements.

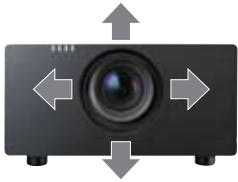

There are 5 optional lenses, 4 of which can be easily adjusted via motorised lens-shift, zoom and focus.

Picture-in-Picture and Side-by-Side display

Display 2 sources simultaneously with a small inset from the main image or display both sources side by side.

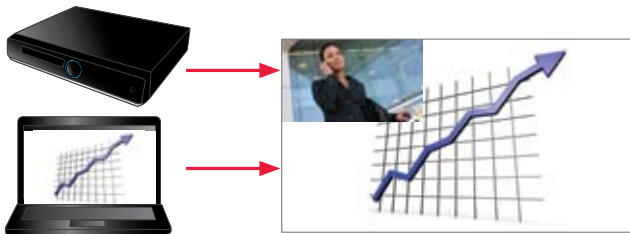

Compare two sets of data side-by-side; the possibilities are endless.

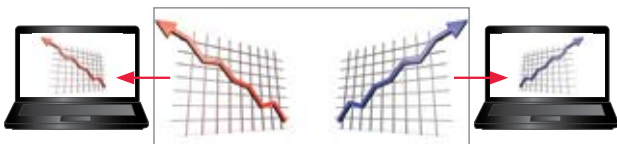

Motorised Lens Shift

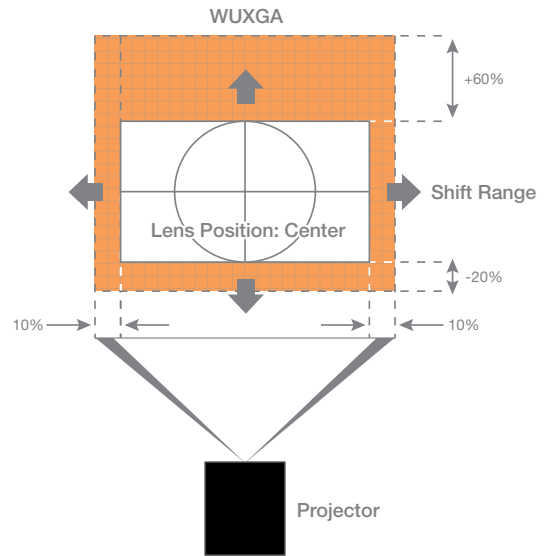

Interchangeable colour wheels

Two colour wheel options ensure the performance characteristics of the EH7500 can be tailored to match the application. The standard colour wheel maximises brightness whilst ensuring good colour reproduction, whereas the enhanced-colour "video" wheel maximises colour performance and accuracy. The colour wheels are interchangeable modules and can be fitted or exchanged on site without removing the projector cover.



Bright (Standard)



Video (Optional)

Lens Options

					
Optoma model name	WT1	WT2	ST1	TZ1	TZ2
Throw Ratio	0.78	1.22 ~ 1.47	1.45 ~ 1.95	1.93 ~ 3.71	3.68 ~ 7.04

Control



System Integration Control

Multiple EH7500 can be monitored over LAN and also provide the user with an email message alert in case an error occurs or a lamp fails or needs to be replaced. The web browser interface can also control all aspects of the EH7500.

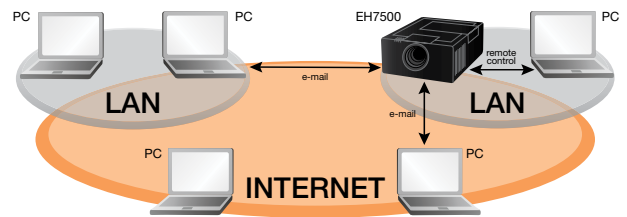
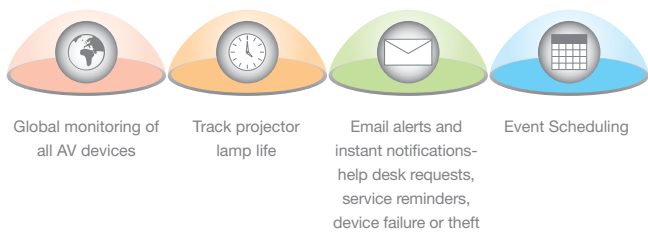

Ultimate control

Cut up to 30% from your energy bills using 24-hour automated power scheduling to ensure that projectors power off when not in use.

Room	Location	Online	Log	Help	Alarm Mute	System Power	Display Power	Display Usage	Lighting	Schedule
Chicago VTC1	550 Madison, 3rd Floor	✓	✓	✗	🔴	🟢	🟢	📊	💡	🕒
Chicago VTC2	550 Madison, 4th Floor	✓	✓	✗	🔴	🟢	🟢	📊	💡	🕒
Chicago VTC3	1400 Fullerton, 17th Floor	✓	✓	✗	🔴	🟢	🟢	📊	💡	🕒
Chicago VTC4	1400 Fullerton, 2nd Floor	✓	✓	✗	🔴	🟢	🟢	📊	💡	🕒
London Conf1	299 Orchard, 1st Floor	✓	✓	✗	🔴	🟢	🟢	📊	💡	🕒
London Conf2	300 Regent, 1st Floor	✓	✓	✗	🔴	🟢	🟢	📊	💡	🕒
London VTC1	306 Orchard, 3rd Floor	✓	✓	✗	🔴	🟢	🟢	📊	💡	🕒
London VTC2	300 Regent, 3rd Floor	✓	✓	✗	🔴	🟢	🟢	📊	💡	🕒
NFC Boardroom1	1450 Broadway, 50th Floor	✓	✓	✗	🔴	🟢	🟢	📊	💡	🕒
NFC Boardroom2	1200 5th Ave, 29th Floor	✓	✓	✗	🔴	🟢	🟢	📊	💡	🕒
NFC Conf1	1525 Broadway, 18th Floor	✓	✓	✗	🔴	🟢	🟢	📊	💡	🕒
NFC Conf2	1450 Broadway, 36th Floor	✓	✓	✗	🔴	🟢	🟢	📊	💡	🕒
NFC VTC1	1450 Broadway, 34th Floor	✓	✓	✗	🔴	🟢	🟢	📊	💡	🕒
NFC VTC2	1200 5th Ave, 18th Floor	✓	✓	✗	🔴	🟢	🟢	📊	💡	🕒
NFC VTC3	800 Broadway, 11th Floor	✓	✓	✗	🔴	🟢	🟢	📊	💡	🕒
NFC VTC4	706 9th Ave, 2nd Floor	✓	✓	✗	🔴	🟢	🟢	📊	💡	🕒

- 1 Help Alert**
Real-time interactive Help Desk requests are sorted to come to the top. The Help Desk then has the ability to respond with an automatic message or instant message the room with exact procedures.
- 2 Display Power**
Check on/off status of display power and system power. View a bar graph to monitor the percentage of available projector lamp life and set an alert to notify the services department when a replacement lamp should be ordered before the lamp fails.
- 3 Display Usage**
- 4 Schedule Event**
RoomView Express makes scheduling of recurring or one time events easy. Setting RoomView to automatically power down at midnight throughout the week can save valuable lamp life and ensure security inside the facility.
- 5 Selected View by Rooms, Attributes or Contacts**
RoomView Express gives you the ability to simultaneously view more than 250 rooms from a single screen. Customise RoomView to view by room name, locations and group
- 6 Room Name and Location (sortable)**
- 7 Online Status**
- 8 Event Log**
Automatically generates log files, reports and charts to analyze ROI and budget allocation. Track device usage, call statistics and user history.
- 9 Projector Power**







Download Crestron RoomView® Express for free at www.crestron.com/getroomview

Lenses



Lens Options

					
Optoma model name	WT1	WT2	ST0/ST1	TZ1	TZ2
Focal Length (f) (mm)	11.73	18.1 ~ 21.72	21.5 ~ 28.7	28.6 ~ 54.33	54.06 ~ 102.7
F number	2.2	2.0 ~ 2.3	2.0 ~ 2.3	2.2 ~ 3.0	2.3 ~ 3.16
Zoom Range (Ratio)	Fixed	1.2x	1.33x	1.9x	1.9x
Zoom & Focus Adjustment	Fixed	Motorized			
Throw Ratio	0.78	1.22 ~ 1.47	1.45 ~ 1.95	1.93 ~ 3.71	3.68 ~ 7.04
Throw Distance (m)	0.5 ~ 8.4	0.79 ~ 15.8	0.94 ~ 21.0	1.25 ~ 40.0	2.38 ~ 75.8
Throw Distance (feet)	1.65 ~ 27.6	2.59 ~ 51.9	3.07 ~ 68.9	4.09 ~ 131.1	7.8 ~ 248.7
Projection Image Size	30" ~ 500" inches				
Motorized Lens Shift	Fixed	Horizontal: + / - 10% offset Vertical: - 20% ~ + 60% offset			

Throw Distance Chart

EH7500 Throw Distance									
Diagonal Image Size	WT1	WT2		ST0 / ST1		TZ1		TZ2	
	Fixed (m)	Min (m)	Max (m)	Min (m)	Max (m)	Min (m)	Max (m)	Min (m)	Max (m)
50"	0.84	1.3	1.58	1.56	2.1	2.08	4.0	3.97	7.58
60"	1.01	1.56	1.9	1.87	2.52	2.49	4.8	4.76	9.1
70"	1.18	1.82	2.20	2.19	2.94	2.91	5.59	5.55	10.61
80"	1.35	2.08	2.53	2.5	3.36	3.33	6.39	6.34	12.13
100"	1.68	2.61	3.16	3.12	4.2	4.16	7.99	7.95	15.16
150"	2.52	3.91	4.75	4.68	6.3	6.24	11.99	11.89	22.75
200"	3.36	5.21	6.33	6.25	8.4	8.32	15.98	15.86	30.33
250"	4.2	6.52	7.92	7.81	10.5	10.39	19.98	19.82	37.91
300"	5.04	7.82	9.5	9.37	12.6	12.47	23.97	23.78	45.49

For guide purposes only

Eco Friendly

Cut up to 30% from your energy bills using 24-hour automated power scheduling to ensure that projectors power off when not in use.



Direct Power On

The projector will start up instantly when power is supplied to the Unit. This eliminates the need to manually turn on the projector via the remote control or the keypad, ideal for use in rooms with a “master” power switch.



Signal Power On

The projector will power on when it receives a signal through one of the PC/video inputs. This ensures that the projector is only switched on when it is needed.



Auto Power Off

If after a pre-determined time the projector does not receive a signal, it will turn itself off automatically, conserving power and extending the life of the lamp.



Eco Standby Mode

Reduces energy consumption to less than 1W when the projector is not in use.



We know that improving our products is the best way to reduce our impact on the environment. That's why at Optoma, we design our products to have a long usable life, use fewer materials, ship with the minimum packaging and be free of all possible toxic substances. Naturally, energy efficiency and being recyclable are built in at the design stage. With each new product, we strive towards minimising our environmental impact. For full details of Optoma Project Green please visit our website.

Dimensions

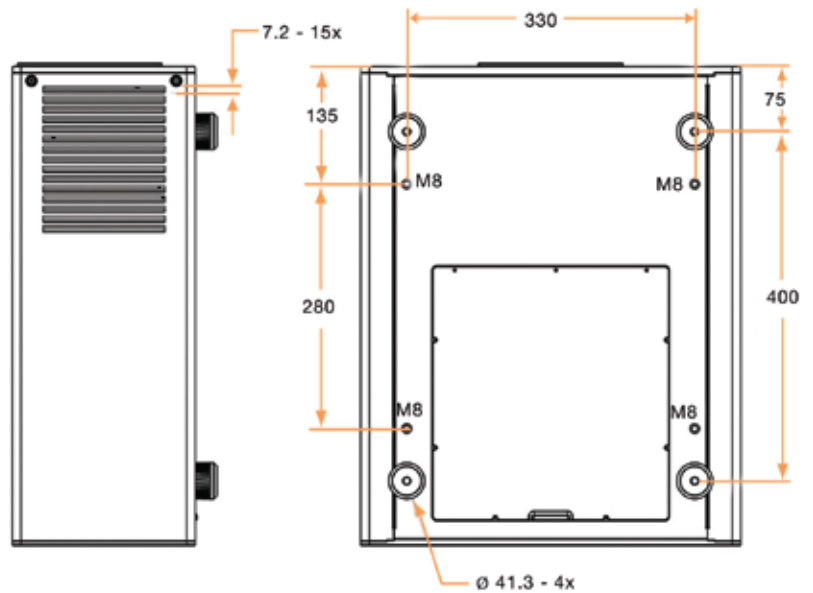
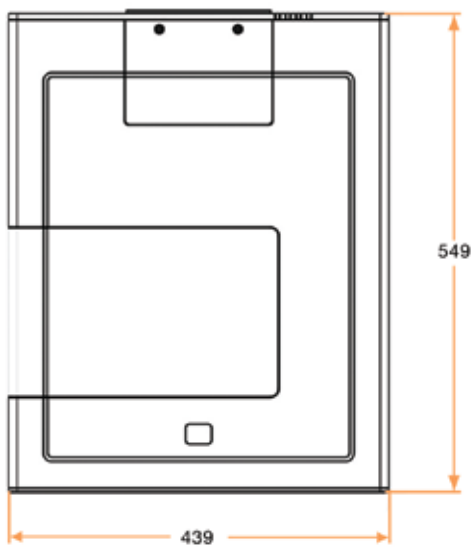
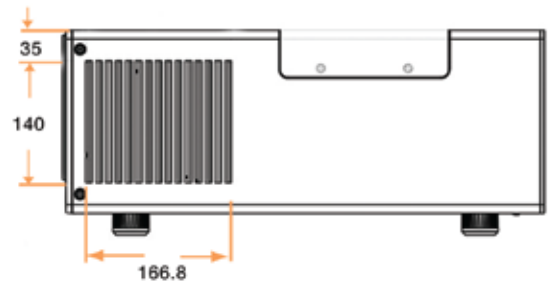
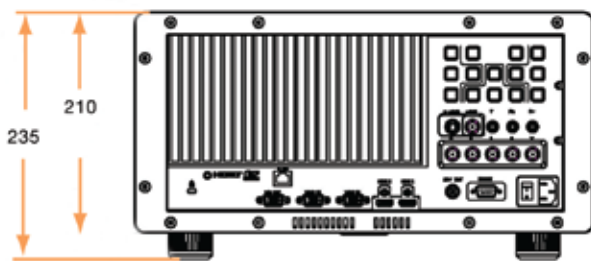

All measurements are in mm

Labelling

Easy to use remote control

- 1 Power On
- 2 Power Off
- 3 Function 2
- 4 Lens Zoom +/-
- 5 Lens Shift
- 6 LED Indicator
- 7 Display Mode
- 8 Keystone +/-
- 9 TV Tigger On/Off
- 10 YPbPr
- 11 RE-sync
- 12 VGA 1
- 13 Audio In (VGA 1 & 2)
- 14 BNC
- 15 S-Video
- 16 Numberd keypad (for password input)
- 17 Freeze
- 18 AV Mute
- 19 Function 1
- 20 Lens Focus +/-
- 21 Enter Help
- 22 Four Directional Select Keys
- 23 Menu
- 24 Format (Image Aspect Ratio)
- 25 Information
- 26 HDMI 1
- 27 HDMI 2
- 28 Video

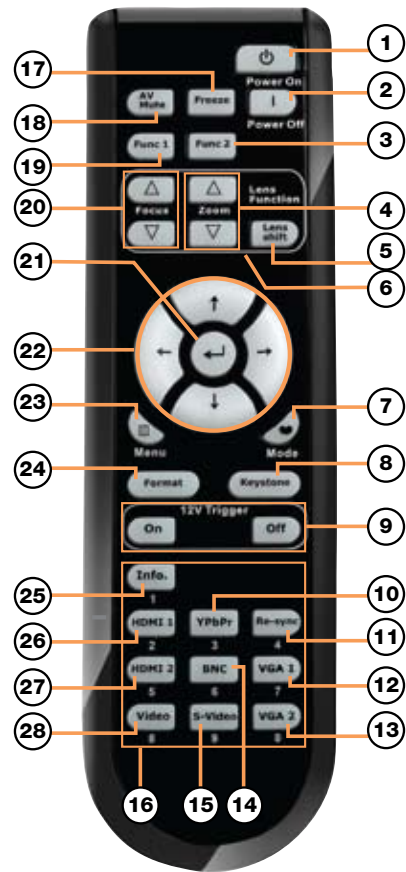

Input/Output Connections

- 29 S-Video Input Connector
- 30 Composite Video Input Connector
- 31 Component Video Input Connector (YPbPr)
- 32 BNC Input Connector (YPbPr/RGBHV)
- 33 Kensington™ Lock Port
- 34 RJ-45 Networking Connector
- 35 VGA-Out Connector (Monitor Loop-through Output)
- 36 VGA2-In/YPbPr Connector (PC Analog Signal/Component Video Input/HDTV/YPbPr)
- 37 VGA1-In/YPbPr Connector (PC Analog Signal/Component Video Input/HDTV/YPbPr)
- 38 HDMI 1 Connector
- 39 HDMI 2 Connector
- 40 12V Trigger Relay Connector (12V, 250mA)
- 41 RS-232 Connector (9-pin DIN Type)
- 42 Power Switch
- 43 Power Socket



Key pad

- 44 Power
- 45 Source
- 46 Re-Sync
- 47 Lens Shift
- 48 Info
- 49 Menu
- 50 Enter
- 51 Focus
- 52 AV Mute
- 53 Control Keys
- 54 Zoom

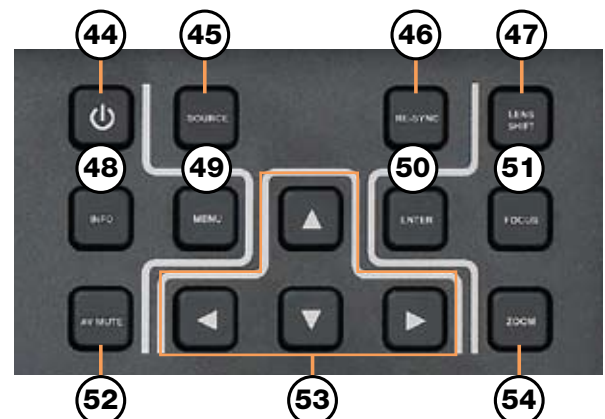

Technical Specifications



Projector		DLPTM Technology by Texas Instruments
	Technology	0.67" WUXGA, DC3, Type A chip
	Resolution	Native WUXGA (1920 x 1200)
	Brightness - Dual Lamp	6000 ANSI lumens / 6500 centre lumens using "Bright" colour wheel
	Aspect Ratio	16:10 native, 4:3 & 16:9 compatible
	Refresh Rate	15kHz to 100kHz / 25Hz to 85Hz
	Contrast	2000:1
	Video Compatibility	PAL (625/576i/p), SECAM, NTSC (525/480i/p), HDTV (720p, 1080i)
Optics		
	Lamp Type	2 x 330W P-VIP
	Lamp Life	2000 hr bright mode / 2500 hr ECO mode (5000 hr ECO relay mode)
	Colour Wheel Options	Bright wheel 6 Segment RGBCYW Video wheel 6 Segment RGBCYM
	Lens Shift	Motorised lens shift, focus and zoom (+60% -20% V, ±10% H)
	Lenses (no lens supplied as standard)	
	WT1	Short throw 0.78 (Fixed)
	WT2	Wide 1.22~1.47 (1.2x zoom)
	ST0	Standard 1.45~1.95 (1.33x zoom)
	ST1	High quality" 1.45~1.95 (1.33x zoom)
	TZ1	Long 1.93~3.71 (1.9x zoom)
	TZ2	Extra long 3.68~7.04 (1.9x zoom)
	Keystone Correction	Horizontal +20° / vertical ±20°
	Uniformity	95% (centre)
Connectivity		
	Inputs	2 x HDMI (with locking screw) BNC (RGBHV) PC RGB 2 x 15 Pin D-Sub VGA Component 3RCA S-Video/Composite 4 pin Mini DIN / RCA
	Output	PC (monitor loop-through) VGA Out +12V trigger low-voltage DC connector
	Control and Communication	RS232 9pin D-SUB RJ45
General		
	Noise Level	39dB
	Weight	24Kg (without lens)
	Dimensions (W x D x H)	439 x 549 x 235mm
	Power Requirements	100 – 240V AC @ 50 – 60Hz
	Power Consumption	900w bright mode < 1w standby mode
	Heat Dissipation	3171 BTU/hr.
	Operating Conditions	760w ECO mode <1w standby mode 5 ~ 35°C, max. humidity 85%, max. altitude 3000m
	Operating Temperature	0 -- 2500 FT, 5 -- 40°C 2500 -- 5000 FT, 5 -- 35°C
	Environmental	RoHS and WEEE
	Conformances	CE, TUV-GS, CB
	Security	4-digit PIN code Kensington Lock port
	Warranties	3 Years
Supplied Accessories		
	Cables	VGA cable AC power cord
	Other	Infra-red remote control, 4x IR code sets for controlling multiple units. Batteries x 2 User manual CD Quick start card Warranty card WEEE card

Accessories

Flying Frame EH7500

Part Nr: P5640

The safest way for handling a projector in rental & staging applications is by using it in combination with a flying frame. The projector is fitted on a bottom frame that is adjustable in 3 axes, allowing the projector to be lined out on screens with high accuracy.

This frame can be used in combination with a second frame and projector for i.e. 3D. The stack frame has mounting holes for truss hooks or chains. A projector mount (**392311b**) is necessary to fix the projector to the stack frame (4 x 8M).



Short Ceiling Mount

Part Nr: 390065b

The universal ceiling mount 390065b is a rigid and strong ceiling mount suited for suspending EH7500 or EX855 and EW865 projectors from the ceiling.

- Maximum load 70 Kg
- Standard equipped with the patented ball-joint.
- Maximum adjustment angle 20 degrees
- Fixed length of 165 mm
- Mounting pattern 90 x 90 mm suited for EH7500 and EX855/ EW865 projector mounts



Long Ceiling Mount

Part Nr: 390061b

The universal ceiling mount 390061b is a rigid and strong ceiling mount suited for suspending EH7500 or EX855 and EW865 projectors from the ceiling.

- Maximum load 70 Kg
- Standard equipped with the patented ball-joint
- Maximum adjustment angle 20 degrees
- Adjustable between 700-940 mm
- Mounting pattern 90 x 90 mm suited for EH7500 and EX855/ EW865 projector mounts



Projector Base Plate

Part Nr: 392311b for EH7500

Part Nr: 392315b for EX855/EW865

The above will need a projector base plate, EH7500 (392311b) and the EX855/EW865 (392315b).

Both base plates use 4 x 8M screws to attach your projector and the ceiling mount plate uses 4 x M6.



Accessories Continued

17990 Flight Case EH7500

Heavy Duty flight case with wheels and handles and can also carry two extra lens plus space for cables and remote.

- Part Number: 17990
- Weight 32 kilo
- Shipping dimensions 930 x 555 x 445mm



Optimised edge blending (Available direct from optoma)

Optoma have worked in partnership with Calibre to produce special versions of Calibre's edge blending and warping products optimised for use with our ProScene projectors. This unique collaboration significantly reduces the complexity and configuration time required to edge blend multiple ProScene projectors and is covered by the industry leading ProScene technical support services should you require assistance with your edge blending project.



HQView320 HQV™ Scaler with Warp and Edge Blend

Best in class professional image processing in a compact affordable module.



HQView520 Universal HQV™ Scaler-Switcher-Scan Converter with Warp, Edge Blend & 3G-SDI In/Out

Use as a routing switcher and universal interface for 3G-SDI, HD-SDI, DVI or HDMI





Worldwide technical and commercial support

Optoma Europe

Optoma Europe Ltd.

42 Caxton Way
The Watford Business Park
Watford
Hertfordshire
WD18 8QZ
UK
Tel: +44 (0) 1923 691 800
Fax: +44 (0) 1923 691 888

Optoma Deutschland GmbH

WIESENSTRASSE 21
D40549 Düsseldorf
Germany
Tel: +49 (0) 211 506 6670
Fax: +49 (0) 211 506 66799

Optoma France

Batiment E
81-83 avenue Edouard Vaillant
92100 Boulogne Billancourt
France
Tel. : +33 (0) 1 41 46 12 20
Fax: +33 (0) 1 41 46 94 35

Optoma Spain

C/ José Hierro,36 Of. 1C
28529 Rivas VaciaMadrid
Madrid
Spain
Tel: +34 91 499 06 06
Fax: + 34 91 670 08 32

Optoma Benelux

Optoma Benelux BV
Randstad 22-123
1316 BW Almere
The Netherlands
T: +31 (0) 36 820 0252
F: + 31 (0)36 548 9052

Local Representatives

Turkey

UAE

Poland

Russia

Italy

Optoma Scandinavia

Optoma Scandinavia

Lerpeveien 25
Postboks 9515 Åskollen
3038 Drammen
Norway
Tel: +47 32 98 89 90
Fax: +47 32 98 89 99

Optoma USA

Optoma USA Headquarters

3178 Laurelview Ct.
Fremont, CA 94538
Tel: (510) 897-8600
Fax: (510) 897-8601

Atlanta Sales Office

7000 Central Park NE, Suite 570,
Atlanta, GA 30328
Tel: (678) 281-2228
Fax: (770) 399-3035

Canadian Sales Office

2420 Meadowpine Blvd, Suite 105,
Mississauga, ON L5N 6S2, CANADA
Tel: (905) 285-0685

Optoma Asia

Taiwan

Optoma Corporation
Taipei Office
5F., No. 108, Minchiuan Rd. , Shindian City,
Taipei Taiwan 231, R.O.C.
Tel: +886-2-2218-2360
Fax: +886-2-2218-2313
<http://www.optoma.com.tw>

Taichung Office

7F-5, No.3, Lane 2, 1st Rd, Taichung Industrial
Park, Xitun Dist., Taichung City, 40767, Taiwan,
R.O.C.
Tel: +886-4-3505-0336
Fax: +886-4-3505-0338

Kaohsiung Office

Rm. D, 7F, No.108, Zhonghua 3rd Rd., Qianjin
Dist., Kaohsiung City 80145, Taiwan, R.O.C.
Tel: +886-7-952-5689
Fax: +886-7-241-2197

China

Shanghai Office
5F, No. 1205 Kaixuan Road, Changning
District , Shanghai
Tel: +86-21-6294-7376
Fax: +86-21-6294-7375
<http://www.optoma.com.cn>

Beijing Office

20D apartment 3, Build No.3, Yindu Tower, No
48 ZhiChun road, HaiDian district, Beijing
Tel: +86-10-5873-1919
Fax: +86-10-5873-1919 *8018

ShenYang Office

Room1201, building C3, Wulihe Tower, No 4-1
WenTi road, HePing district, ShenYang
Tel: +86-024-3188-7018
Fax: +86-024-3188-7018-808

Xi'an Office

Room 1310, building B, ShiMao tower,
GuanDongZheng street, Xi'an
Tel: +86-029-8228-2428
Fax: +86-029-8228-2428

GungZhou Office

Room 602, NanTie Tower, No.57
No.1ZhongShan road, YueXiu district,
GungZhou
Tel: +86-20-6128-0990 / 6128-1025
Fax: +86-20-6128-1027

ChongQing Office

Room 9-2, building 19 HuaYuMingDu,
ShiQiaoPu, ChongQing
Tel: +86-23-6879-7626
Fax: +86-23-6879-7725

ChengDu Office

Room A3 floor 20, building A Time digital
square, No.1 South RenMin road, ChengDu
Tel: +86-28-8523-1553 / 8631-7092

Hong Kong Office

Unit A, 27/F., Dragon Centre, 79 Wing Hong
Street, Cheung Sha Wan, Kowloon, Hong Kong
Tel: +852-2396-8968
Fax: +852-2370-1222
<http://www.optoma.com.hk>



Optoma Europe Ltd.

42 Caxton Way, Watford Business Park, Watford, Hertfordshire, UK. WD18 8QZ

www.optoma.eu



Brightness and lamp lifetime will vary depending on selected projector mode, environmental conditions and usage. As is common with all lamp based projectors, brightness will decrease over the lamp lifetime. Typical lamp life achieved through testing. Will vary according to operational use and environmental conditions. Optoma guarantees that in normal use, Optoma DLP® colour quality will be indistinguishable from when new. Exclusions: (a) Guarantee is voided if the projector is subject to damage through misuse. (b) Guarantee may be void in industrial or commercial entertainment environments where dust or smoke is excessive (c) Guarantee will not apply if lamp brightness is below 50% due to wear or if the projector is not working due to other faults. (d) Over time worn lamps within all projector types will show a slight colour variance. Copyright © 2011, Optoma Europe Ltd. All other product names and company names used herein are for identification purposes only and may be trademarks or registered trademarks of their respective owners. Crestron®, the Crestron and RoomView® logo are registered trademarks of Crestron Electronics, Inc. Errors and omissions excepted, all specifications are subject to change without notice. DLP®, BrilliantColor™ and the DLP logo are registered trademarks of Texas Instruments. All images of products are for representation purposes only. Whilst every care is taken to provide accurate images of our products, actual products may differ slightly. Some product images may have been digitally altered by us to add an Optoma logo to the front panel. Optoma reserves the right to amend or alter actual product or product images without notice. Some images may be simulated.